

Domestic panel mounting socket outlet for use in stationary distributor systems - flange 50x50 fixing centers 38x38



Product description	
BALS-Prd.-Nr	71100
EAN	4024941962155
Product category	Domestic panel mounting socket outlet QUICK-CONNECT screwless push-contact System F German standard
Current	16A
Number of poles	3p
Arrangement of phases	2P+PE
Voltage	250V~

Product description	
Frequency	AC
Protection degree	IP54
Colour code	grey RAL 7035
Colour of appliance	Hinged lid grey RAL 7035, Enclosure grey RAL 7035
Connection design	screwless
Maximum conductor size	2,5 qmm
Cable entry	other
Height	61.5mm
Width	50mm
Depth	47.5mm
Flange size vertical in mm	50mm
Flange size horizontal in mm	50mm
Drill hole dist. vertical mm	38mm
Drill hole dist. horizontal mm	38mm
Material of enclosure	plastic
Contacts	the contact carrier is made of polyamide, the contacts are brass nickel plated

Additional technical properties	
	The connection is rear, with german earthing system, For use in stationary distributor distributor systems

Logistics data	
Weight/pcs	0.062 kg / Piece
Packaging	Bag
Content amount	1 ST
EAN	4024941962155
Length	47.5 mm
Width	50 mm
Height	61.5 mm
Weight	0.063 kg
Volume	146.063 ccm
Packaging	Carton
Content amount	20 ST
EAN	4024941959100
Length	276 mm
Width	174 mm
Height	80 mm
Weight	1.352 kg
Volume	2,808 ccm

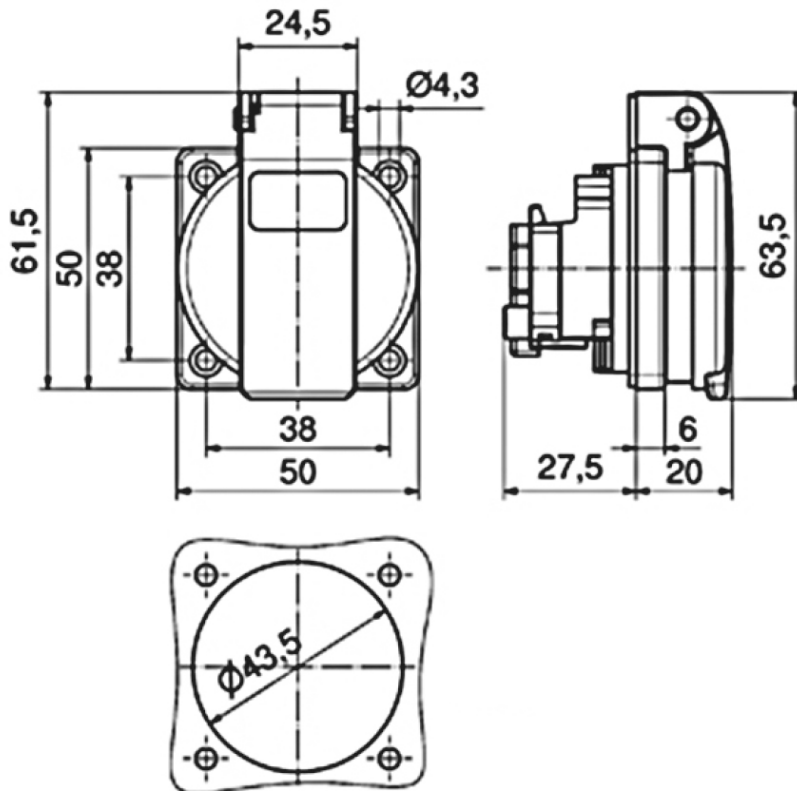
**18 MB 102**



