

ILVY-FIX 100.TWL.50.WH-BK/DALI

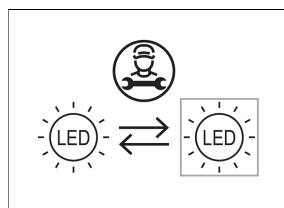

Farbe	Artikelnummer	EAN
weiß	658452	4043544673664

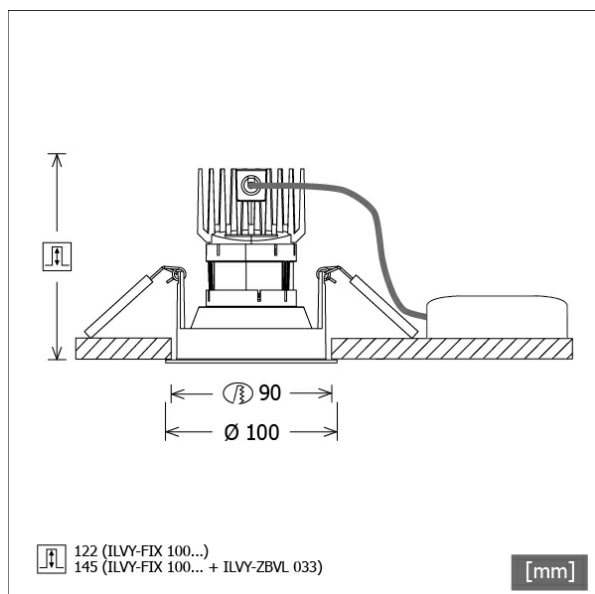

Beschreibung

- rundes Einbau-Downlight mit Tunable White Light (TWL)
- Frontring weiß / Innenkonus schwarz
- Leuchte mit halogenfreier Verdrahtung
- hohe Wartungsfreundlichkeit
- keine UV- und Wärmestrahlung
- Wärmemanagement mit Passivkühlung (Kühlkörper aus Aluminiumdruckguss)
- LED mit vollem Tageslichtspektrum
- Reflektorhalter aus schwarzem ABS
- metallbedampfter Hochglanz-Polycarbonatreflektor mit präziser symmetrischer Abstrahlcharakteristik für maximale Lichtausbeute und optimale Entblendung (inklusive Kunststoff-Schutzglas)
- Innenkonus aus ABS
- Konusverlängerung ILVY-ZBVL 033 zur Blendungsverbesserung optional als Zubehör separat bestellen (Einbautiefe beachten: 145 mm)
- Front-/Einbauring aus Aluminiumdruckguss
- werkzeugloser Deckeneinbau mit Schnellspannfedern (automatische Anpassung der Deckenstärke)
- Anschluss an Betriebsgerät über vormontiertes Leuchtenkabel
- Betriebsgerät (LED-Konverter DALI) inklusive (Platzierung extern)

Hinweise

Bei Verwendung der Leuchte in einem geschlossenen Einbaukasten, Maße für Einbaukasten beachten (L x B x H = 500 x 190 x 130 mm).

Standardoptionen

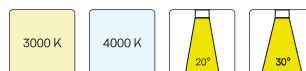

Lichttechnik / Normen

Leuchtmittel	LED Spot TWL / CRI 98 / 2700-6500 K
Lebensdauer	L90 B50 50.000 h L80 B50 100.000 h L80 B20 50.000 h
Systemleistung	14.4 W
Leuchten-Lichtstrom	max. 990 lm
Systemeffizienz	52.77 lm/W
Moduleffizienz	116.32 lm/W
UGR Klasse	≤16
Abstrahlwinkel	50°
Versorgungsspannung	220 - 240 V / 50 - 60 Hz
Schutzklasse	III
Schutzart	IP20

Abmessungen / Gewichte

Außendurchmesser	100 mm
Höhe	113 mm
Ausschnittsmaß (∅)	90 mm
Deckenstärke	12.5 - 50.0 mm
Einbautiefe	122 mm
Nettogewicht	0.56 kg
Bruttogewicht	0.66 kg

ILVY-FIX 100.TWL.50.WH-BK/DALI

ILVY-FIX 100.TWL.50.WH-BK/DALI

Ilvy Fix (2700 K, 1xLED 14W TWL 760lm 50°)

— C0/C180 cd / 1000 lm

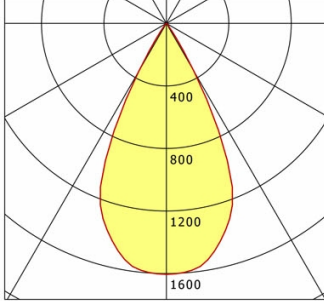

	C0	C90	C180	C270
0°	1605	1605	1605	1605
15°	1405	1405	1405	1405
30°	352	352	352	352
45°	10	10	10	10
60°	1	1	1	1
75°	0	0	0	0
90°	0	0	0	0

cd / 1000 lm

Offset [m] Cone width [m] Illuminance [lx]

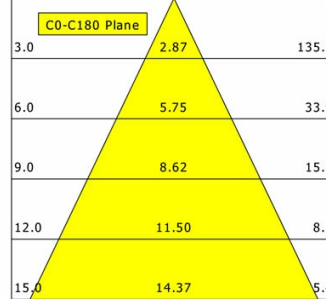

η	LED
Efficiency	54 lm/W
Direct/Indirect	↓ 100% / ↑ 0%
System Power	14 W
UGR	X=4H, Y=8H
Reflection factors	70/50/20
UGR C0/C180	<10.0
UGR C90/C270	<10.0
CIE Flux Codes	99 100 100 100 100
Ra/CRI	>90

LTS

ILVY-FIX 100.TWL.50.WH-BK/DALI

Ilvy Fix (3000 K, 1xLED 14W TWL 780lm 50°)

— C0/C180 cd / 1000 lm

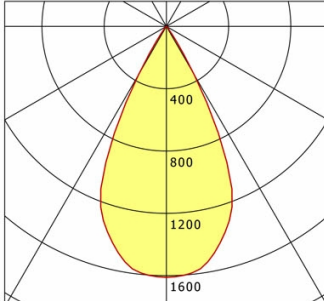

	C0	C90	C180	C270
0°	1611	1611	1611	1611
15°	1402	1402	1402	1402
30°	356	356	356	356
45°	10	10	10	10
60°	1	1	1	1
75°	0	0	0	0
90°	0	0	0	0

cd / 1000 lm

Offset [m] Cone width [m] Illuminance [lx]

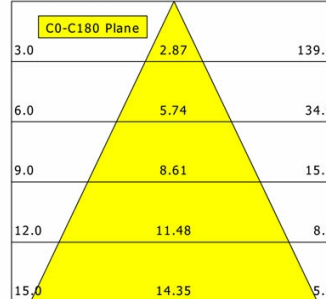

η	LED
Efficiency	56 lm/W
Direct/Indirect	↓ 100% / ↑ 0%
System Power	14 W
UGR	X=4H, Y=8H
Reflection factors	70/50/20
UGR C0/C180	<10.0
UGR C90/C270	<10.0
CIE Flux Codes	99 100 100 100 100
Ra/CRI	>90

LTS

ILVY-FIX 100.TWL.50.WH-BK/DALI

Ilvy Fix (4000 K, 1xLED 14W TWL 840lm 50°)

— C0/C180 cd / 1000 lm

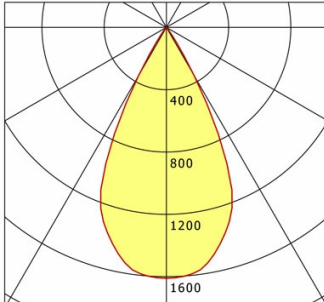

	C0	C90	C180	C270
0°	1611	1611	1611	1611
15°	1402	1402	1402	1402
30°	356	356	356	356
45°	10	10	10	10
60°	1	1	1	1
75°	0	0	0	0
90°	0	0	0	0

cd / 1000 lm

Offset [m] Cone width [m] Illuminance [lx]

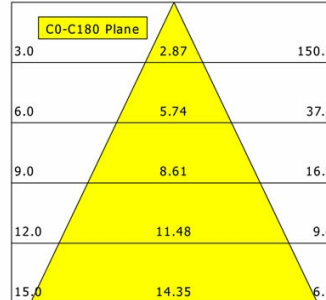

η	LED
Efficiency	60 lm/W
Direct/Indirect	↓ 100% / ↑ 0%
System Power	14 W
UGR	X=4H, Y=8H
Reflection factors	70/50/20
UGR C0/C180	<10.0
UGR C90/C270	<10.0
CIE Flux Codes	99 100 100 100 100
Ra/CRI	>90

LTS

ILVY-FIX 100.TWL.50.WH-BK/DALI

Ilvy Fix (6500 K, 1xLED 14W TWL 990lm 50°)

— C0/C180 cd / 1000 lm

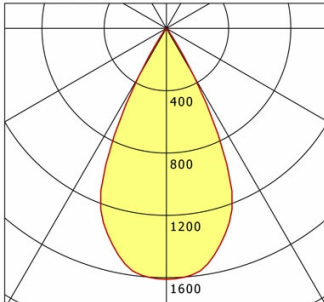

	C0	C90	C180	C270
0°	1611	1611	1611	1611
15°	1402	1402	1402	1402
30°	356	356	356	356
45°	10	10	10	10
60°	1	1	1	1
75°	0	0	0	0
90°	0	0	0	0

cd / 1000 lm

Offset [m] Cone width [m] Illuminance [lx]

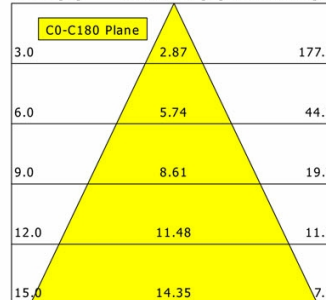

η	LED
Efficiency	71 lm/W
Direct/Indirect	↓ 100% / ↑ 0%
System Power	14 W
UGR	X=4H, Y=8H
Reflection factors	70/50/20
UGR C0/C180	10.3
UGR C90/C270	10.3
CIE Flux Codes	99 100 100 100 100
Ra/CRI	>90

LTS

Einbaustrahler · Ilvy Fix



ILVY-FIX 100.TWL.50.WH-BK/DALI

Zubehör



ILVY-ZBVL 033
Konusverlängerung