

Panel mounting socket outlet low voltage - flange 100x92 fixing centers 85x77 angled execution



Product description	
BALS-Prd.-Nr	4238
EAN	4024941042383
Product category	ELV panel mounting socket Outlet, angled
Current	32A
Number of poles	2p
Arrangement of phases	2P
Position of earth contact	10 h
Voltage	20 up to 25 and 40 up to 50V

Product description	
Frequency	DC
Protection degree	IP44
Colour code	grey RAL 7035
Colour of appliance	Hinged lid grey RAL 7035, Enclosure grey RAL 7035
Connection design	with screw terminal
Maximum conductor size	10,0 qmm
Cable entry	other
Height	100mm
Width	92mm
Depth	70mm
Flange size vertical in mm	100mm
Flange size horizontal in mm	92mm
Drill hole dist. vertical mm	85mm
Drill hole dist. horizontal mm	77mm
Material of enclosure	Polyamide
Contacts	the contact carrier is made of polyamide, the contacts are brass nickel plated

Additional technical properties	
	The inclination is 20°

Logistics data	
Weight/pcs	0.165 kg / Piece
Packaging	Bag
Content amount	1 ST
EAN	4024941042383
Length	70 mm
Width	92 mm
Height	100 mm
Weight	0.166 kg
Volume	644 ccm
Packaging	Carton
Content amount	10 ST
EAN	4024941837224
Length	245 mm
Width	177 mm
Height	185 mm
Weight	1.783 kg
Volume	7,140 ccm

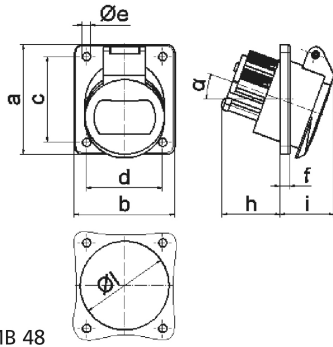

16 MB 48

Ampere Polzahl	16 2	16 3	32 2	32 3		
a	100,0	100,0	100,0	100,0		
b	92,0	92,0	92,0	92,0		
c	85,0	85,0	85,0	85,0		
d	77,0	77,0	77,0	77,0		
e ø	5,2	5,2	5,2	5,2		
f	6,0	6,0	6,0	6,0		
h	36,0	36,0	36,0	36,0		
i	35,0	35,0	35,0	35,0		
α	20°	20°	20°	20°		
l ø	55,0	55,0	55,0	55,0		
Leiter mm ² min	4	4	4	4		
Leiter mm ² max	10	10	10	10		