

Panel mounting socket outlet low voltage - angled execution flange 68x62, fixing centers 53x47



Product description	
BALS-Prd.-Nr	420
EAN	4024941004206
Product category	ELV panel mounting socket Outlet, angled
Current	16A
Number of poles	2p
Arrangement of phases	2P
Position of earth contact	no minor keyway
Voltage	20 up to 25v

Product description	
Frequency	50/60Hz
Protection degree	IP44
Colour code	violet RAL 4005
Colour of appliance	Enclosure grey RAL 7035, Hinged lid violet RAL 4005
Connection design	with screw terminal
Maximum conductor size	10,0 qmm
Cable entry	other
Height	69mm
Width	62mm
Depth	70mm
Flange size vertical in mm	68mm
Flange size horizontal in mm	62mm
Drill hole dist. vertical mm	53mm
Drill hole dist. horizontal mm	47mm
Material of enclosure	Polyamide
Contacts	the contact carrier is made of polyamide, the contacts are brass nickel plated

Additional technical properties	
	The inclination is 20°

Logistics data	
Weight/pcs	0.114 kg / Piece
Packaging	Bag
Content amount	1 ST
EAN	4024941004206
Length	70 mm
Width	62 mm
Height	69 mm
Weight	0.115 kg
Volume	299.46 ccm
Packaging	Carton
Content amount	10 ST
EAN	4024941963008
Length	207 mm
Width	162 mm
Height	142 mm
Weight	1.24 kg
Volume	3,750 ccm

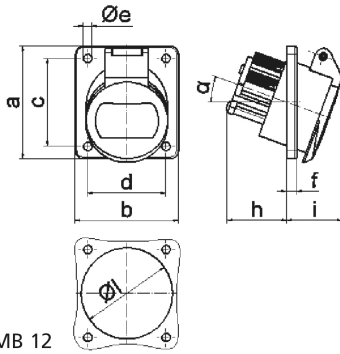

16 MB 12

Ampere	16	16	32	32		
Polzahl	2	3	2	3		
a	68,0	68,0	68,0	68,0		
b	62,0	62,0	62,0	62,0		
c	53,0	53,0	53,0	53,0		
d	47,0	47,0	47,0	47,0		
e ø	5,2	5,2	5,2	5,2		
f	6,0	6,0	6,0	6,0		
h	36,0	36,0	36,0	36,0		
i	35,0	35,0	35,0	35,0		
α	20°	20°	20°	20°		
l ø	55,0	55,0	55,0	55,0		
Leiter mm ² min	4	4	4	4		
Leiter mm ² max	10	10	10	10		